



# WELKOM

---

Van harte welkom op de informatieavond over de (bouw)plannen op Fontys campus Rachelsmolen.

**maandag 30 november 2020**  
**start: 19.30u**



# CAMPUS RACHELSMOLEN



# TU/e CAMPUS

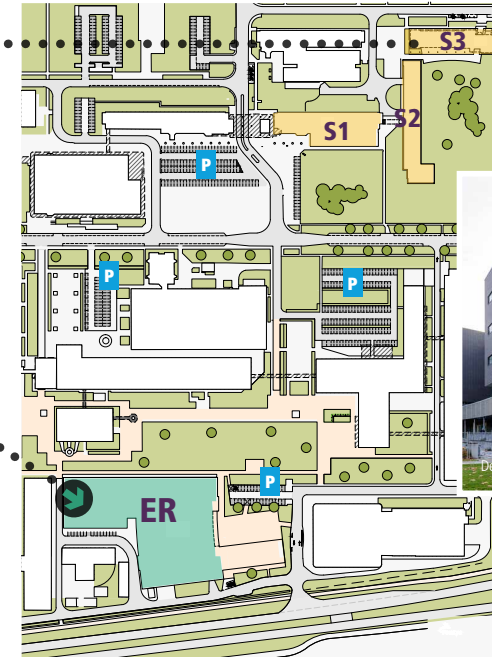

# TH. FLIEDNERSTRAAT

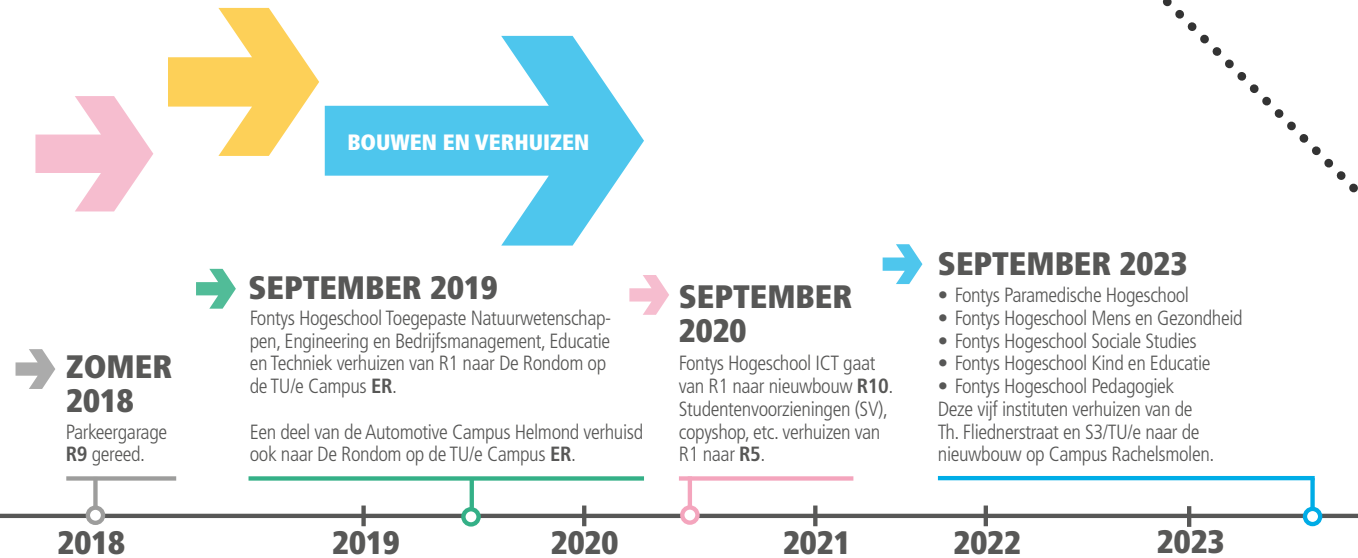

# FONTYS CAMPUS RACHELSMOLEN

bewonersavond | 30-11-2020

**BARCODE**  
ARCHITECTS

OKRA

  
HOLLANDSE NIEUWE

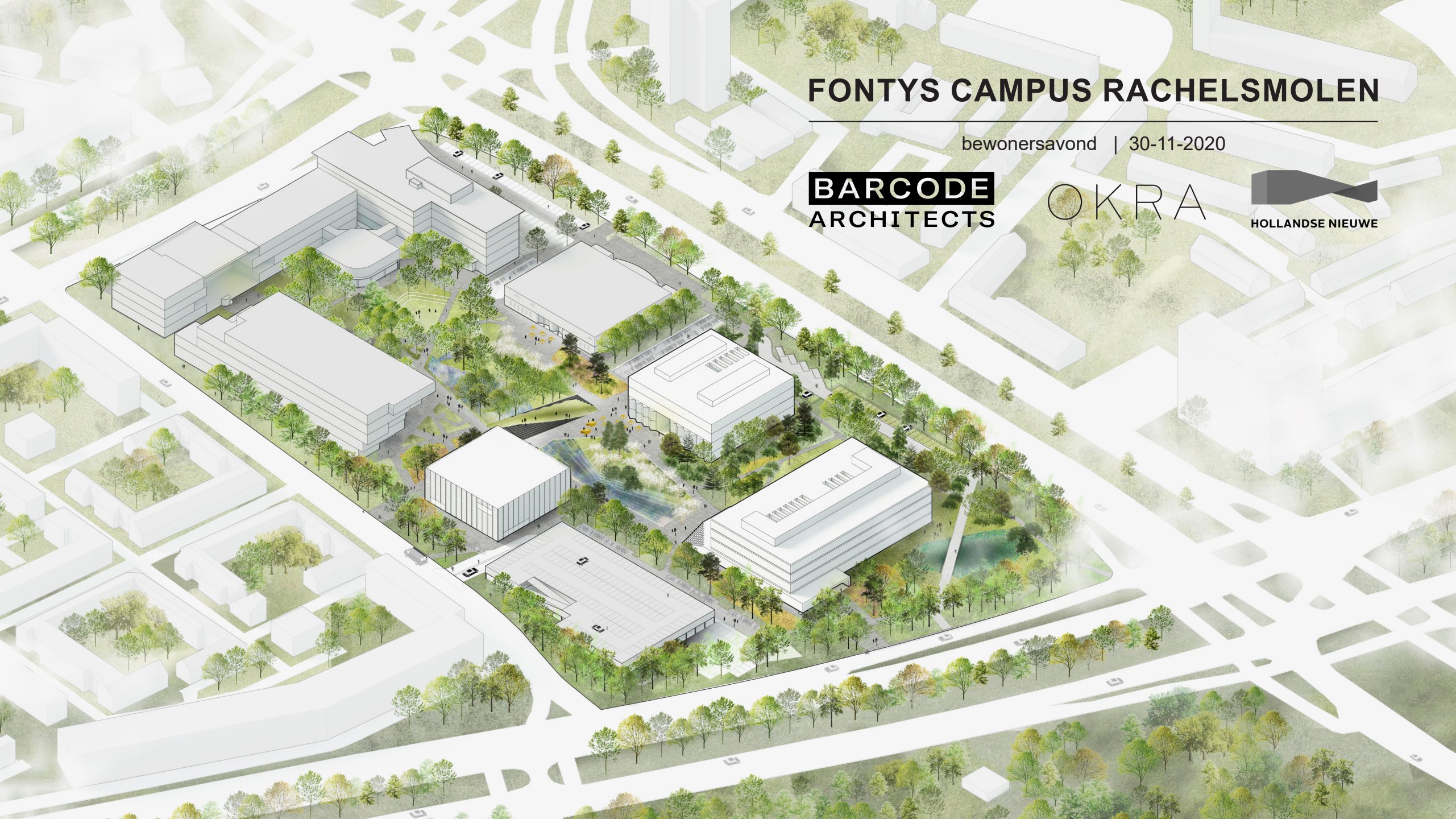



huidige situatie



huidige situatie

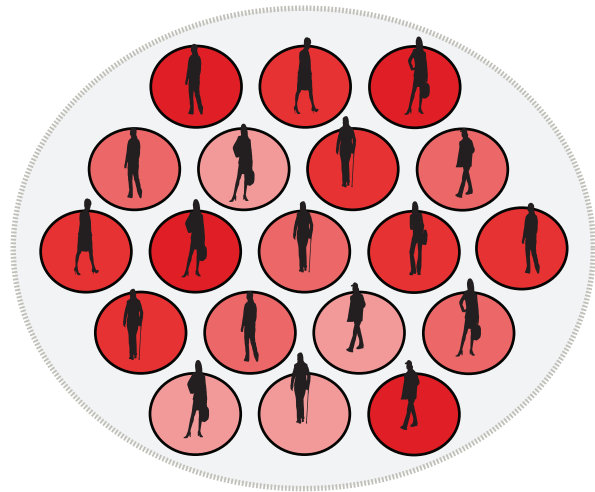

2018



2023



2030

- Fontys Instituten en diensten ●
- Maatschappij ○
- Maatschappij en Fontys volledig verwoven ●

toekomst ambitie: De Circle City Campus



**een campus met een stadsplein: open en uitnodigend naar Eindhoven**

**video**



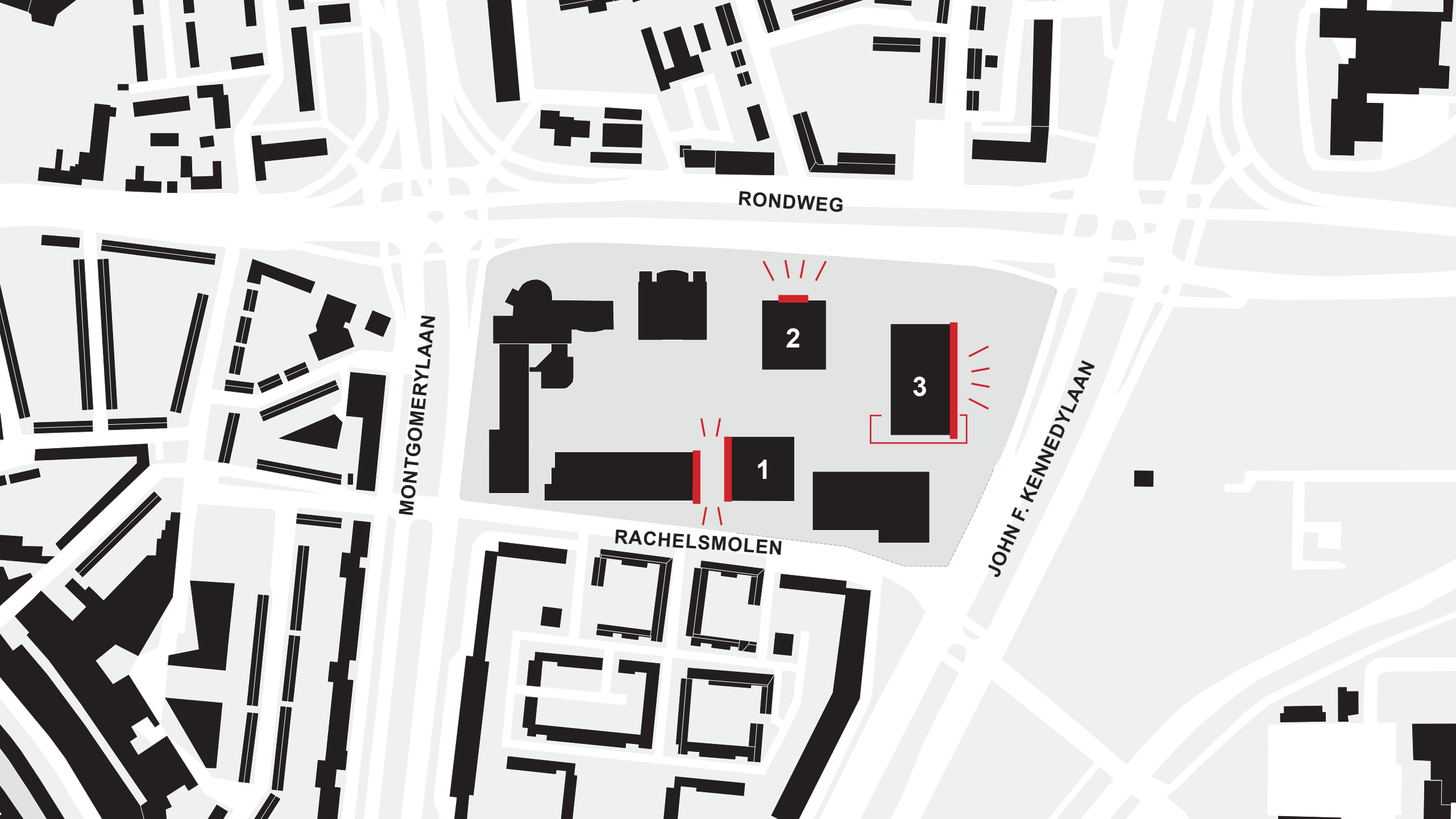

RONDWEG

MONTGOMERYLAAN

JOHN F. KENNEDYLAAN

RACHELSMOLEN

2

3

1

**gebouw 2: zorgcentrum + praktijkgericht  
onderwijs + maakruimte als etalage-functie**

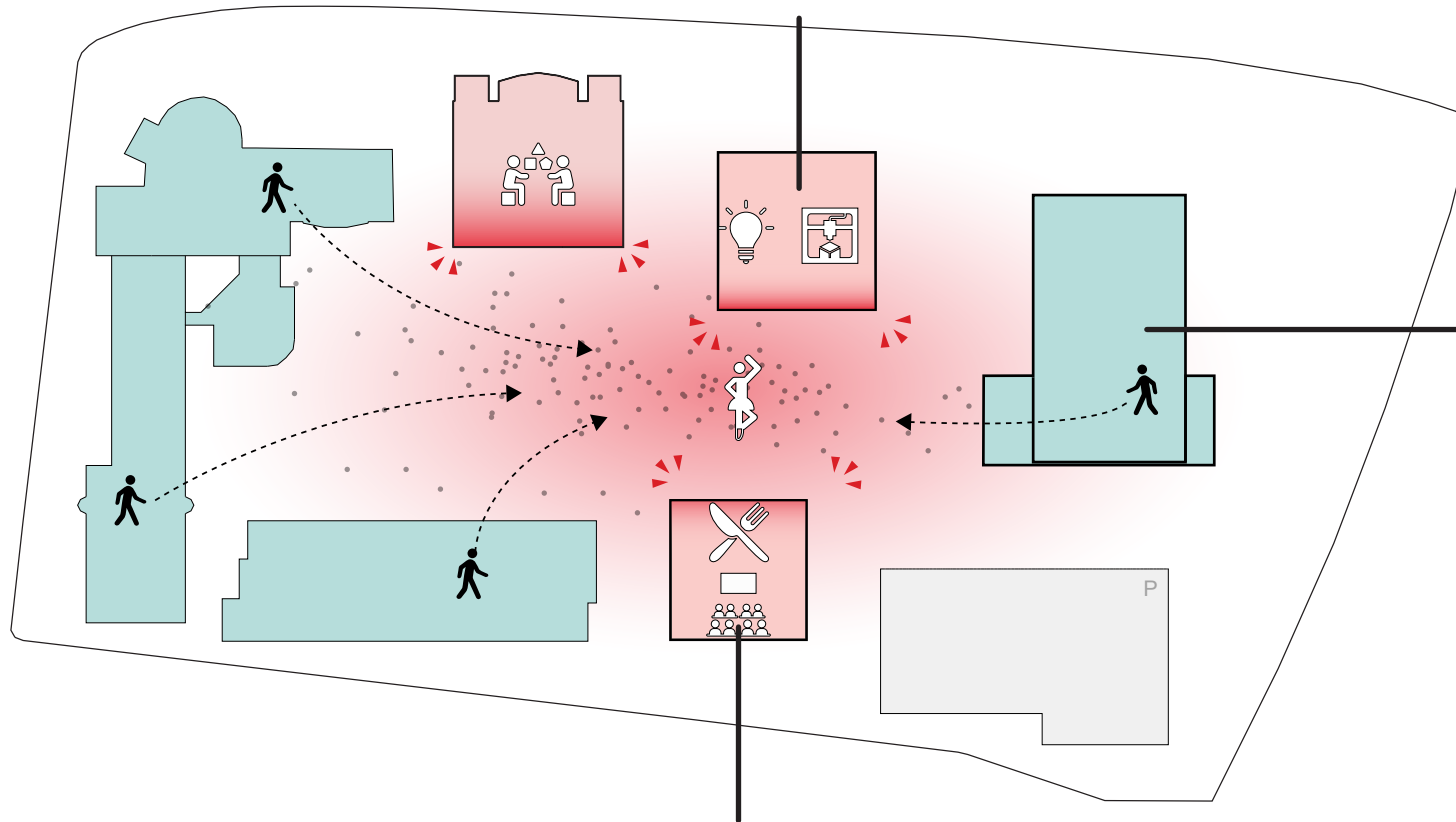

**gebouw 3: flexibel  
onderwijsgebouw (generiek)**

**gebouw 1: campusbrede voorzieningen  
(restaurant / auditorium / mediatheek)**

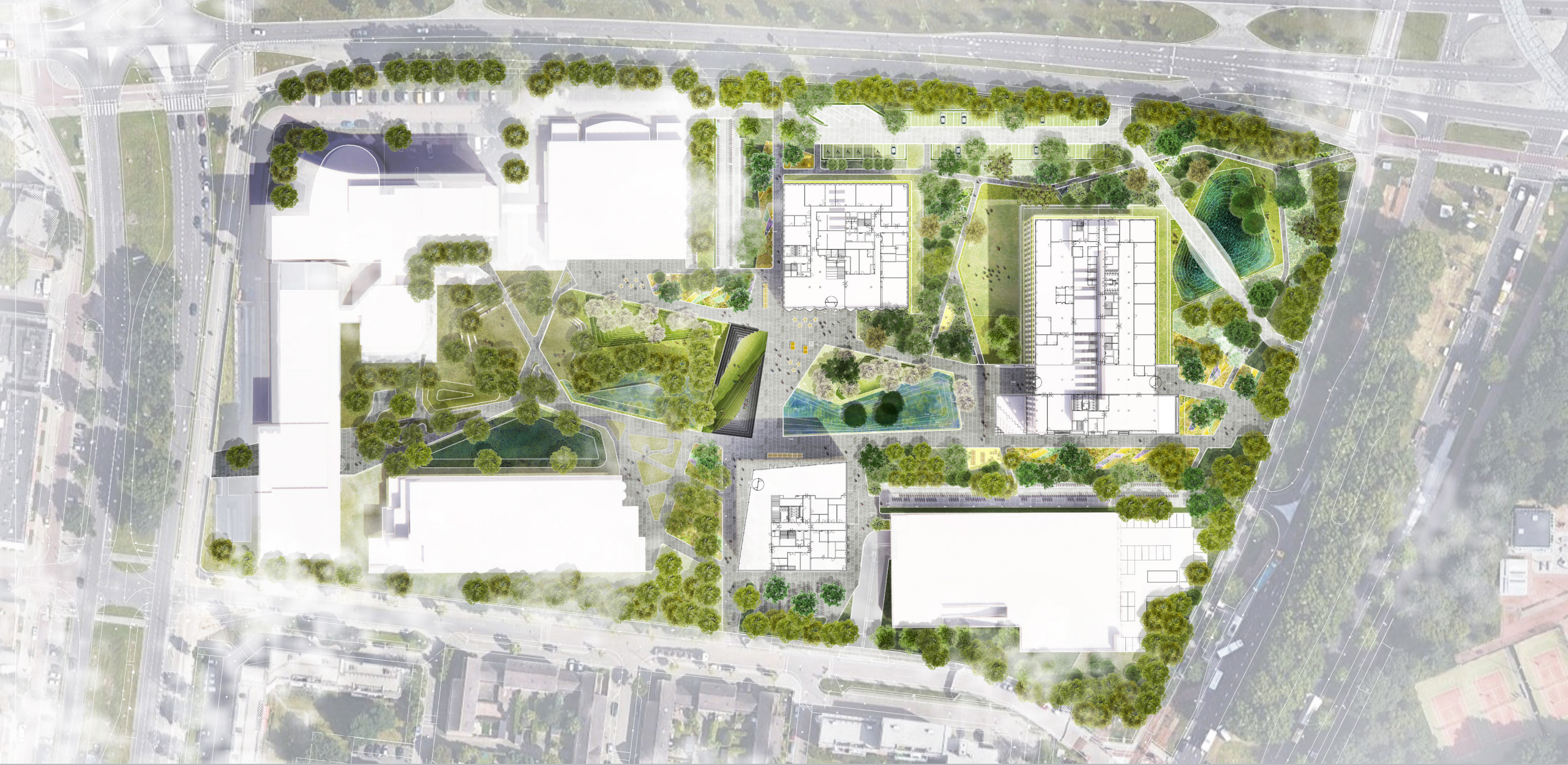

**uniformiteit op de campus**

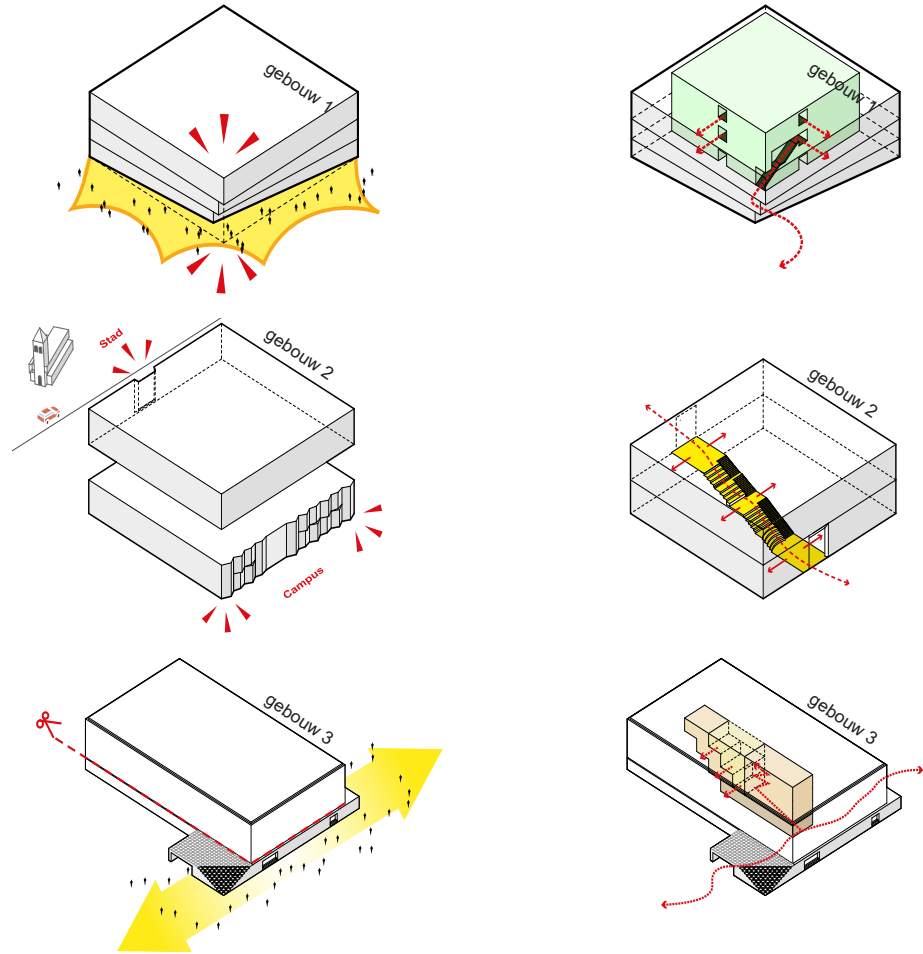
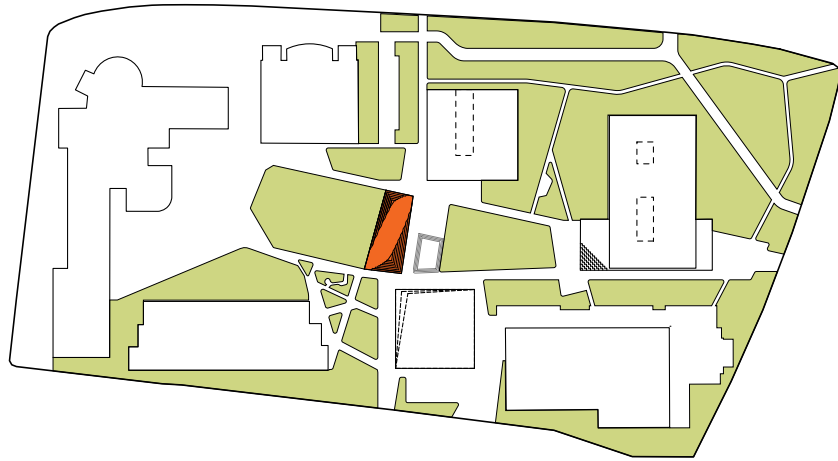

← → CAMPUS ← → GEBOUW ← → INTERIEUR ← →

**robuuste ontwerpen met steeds één heldere ingreep / verrassing die verbindt en identiteit geeft en disciplines van landschap / architectuur / interieur met elkaar verbindt**



het trappen en vouwen van de gevels als gezamenlijke vormtaal

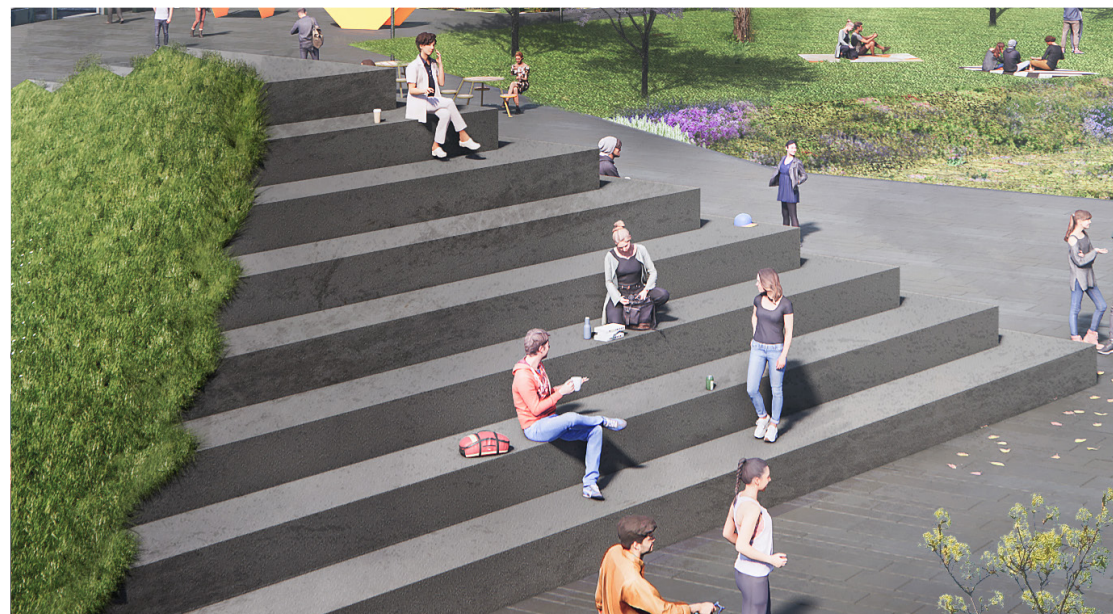

deze vormtaal komt op verschillende schaalniveau's terug in het landschaps- en interieur ontwerp



R10



R3



R4 & R5



parkeergarage R9

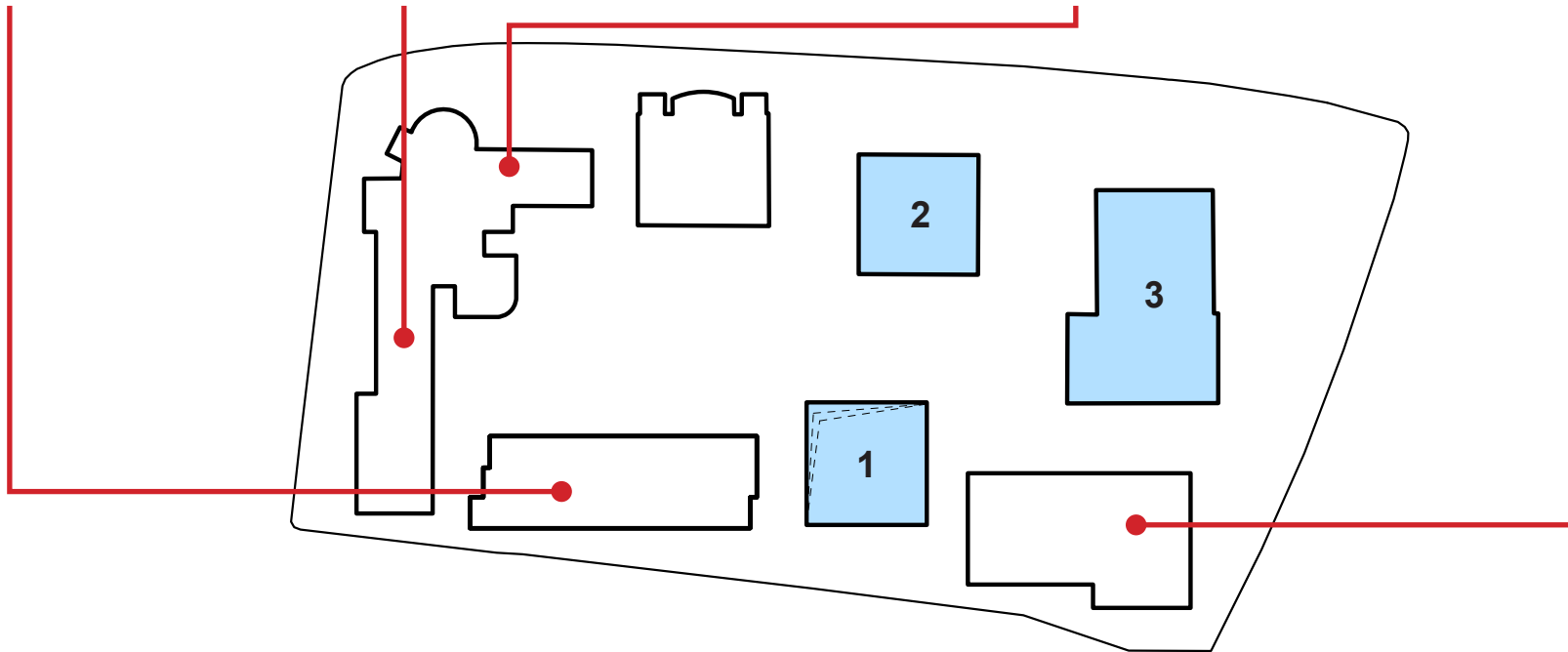

 Nieuwbouw

**Campus Rachelsmolen kenmerkt zich als een verzameling van losse identiteiten**

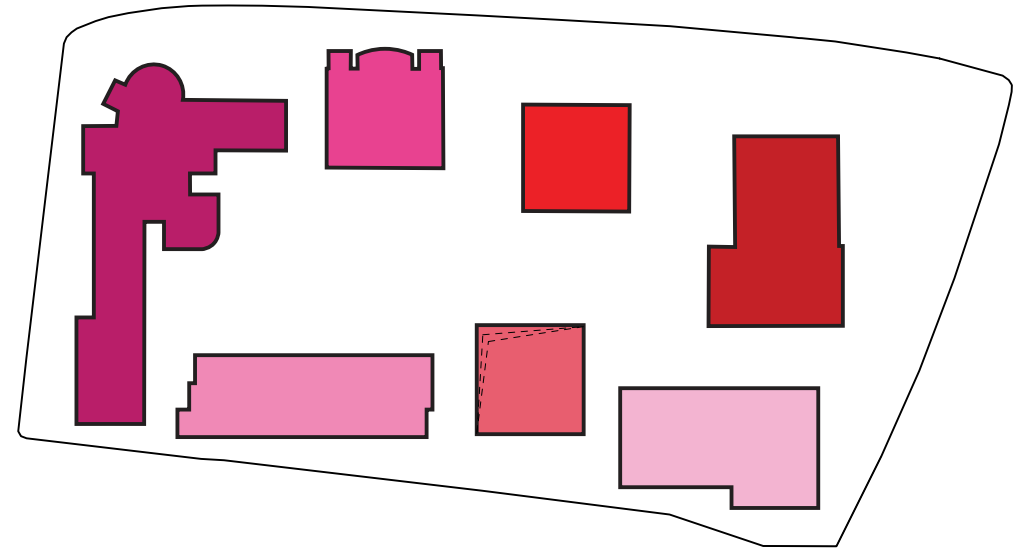
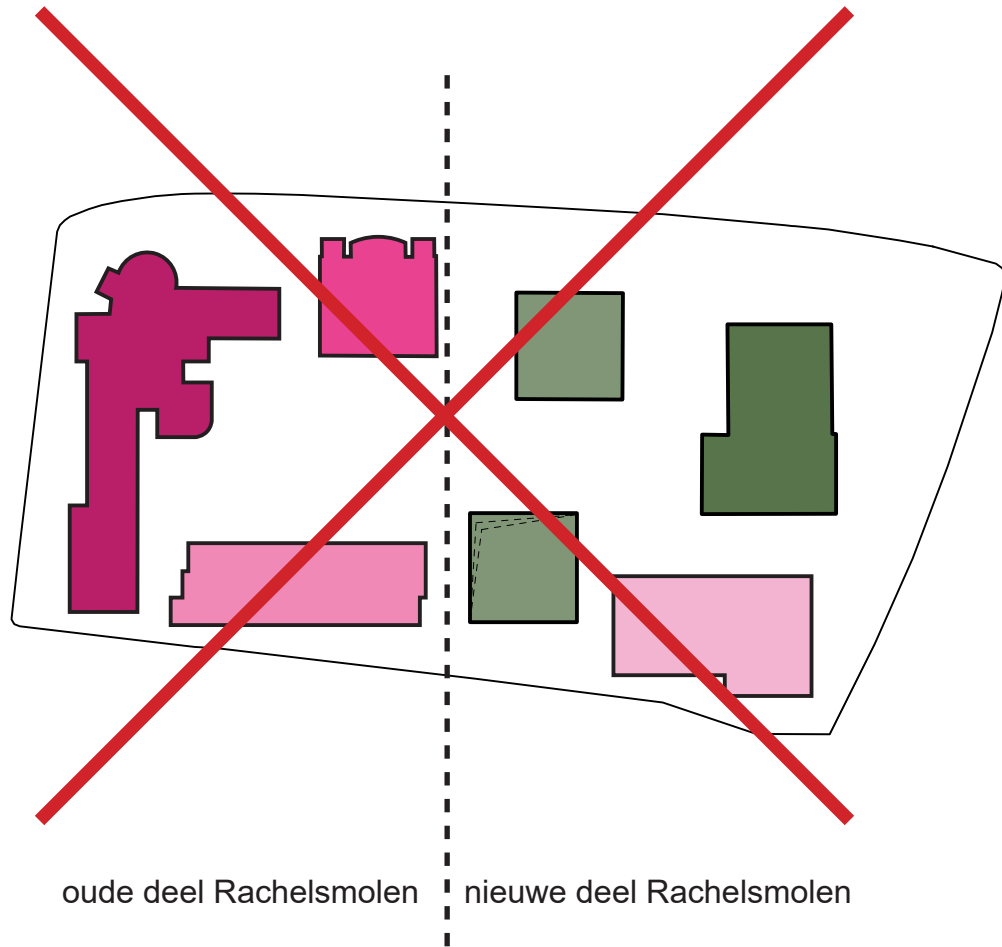

**geen contrast tussen oude en nieuwe deel, maar materialenpallet in harmonie afstemmen**





R4 + R5

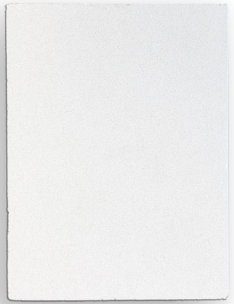

R3

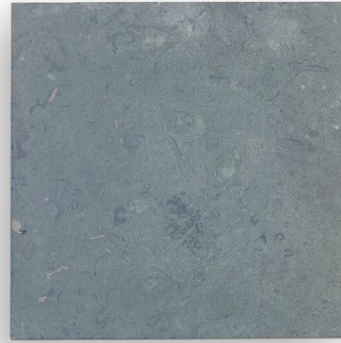

GEBOUW 2



GEBOUW 3



GEBOUW 1



R10

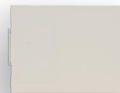

R9



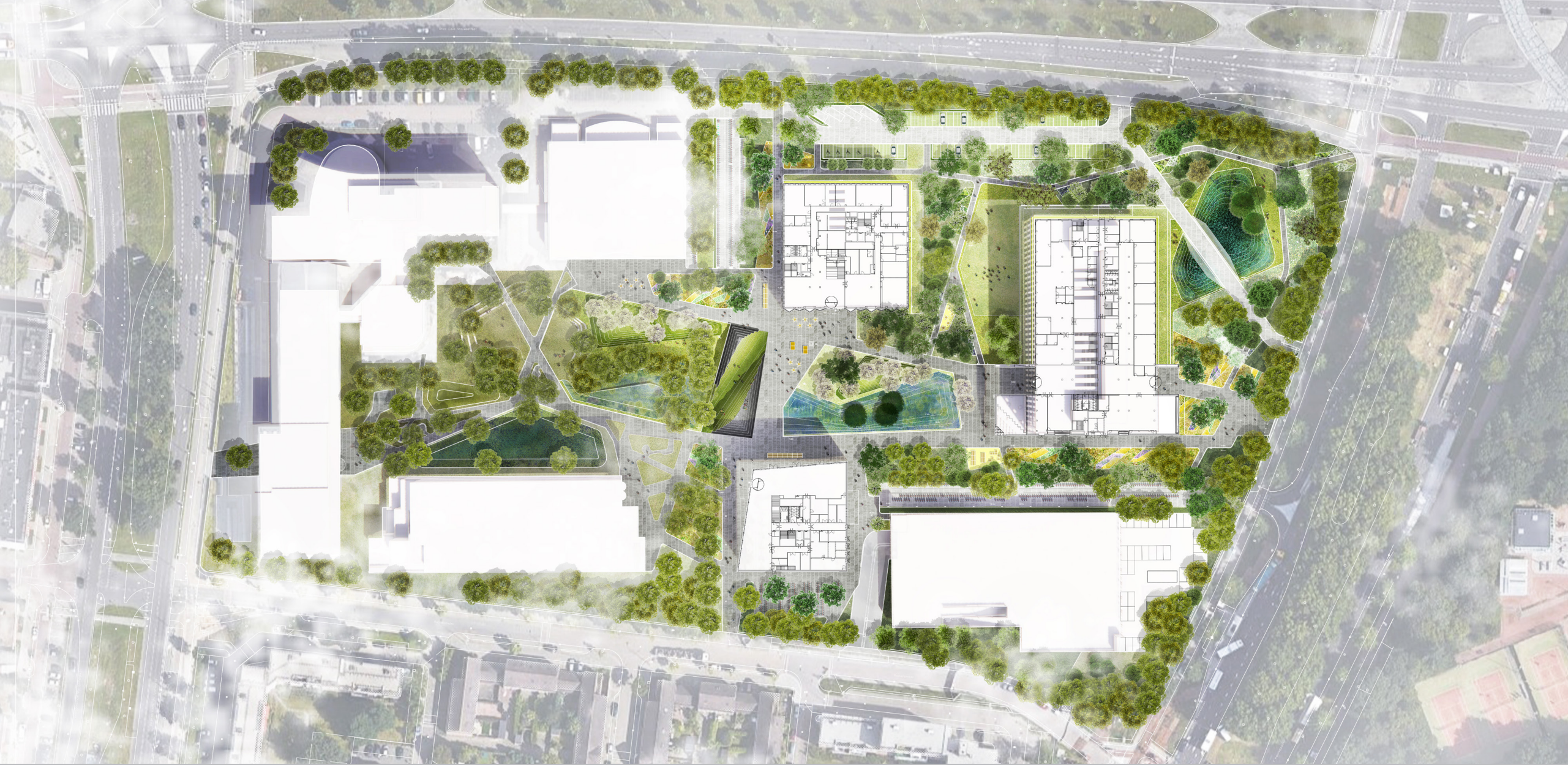

duurzaamheid

# Duurzaamheidsagenda

2020-2023

Ontwikkeling  
duurzame diensten

Gezonde gebouwen  
en omgeving

Energie  
en klimaat

Verduurzamen  
en veranderen  
met impact

Circulair inkopen  
bewuster kiezen

Dienst Huisvesting en Facilitaire Zaken



19 september 2019





**ENERGIELABEL  
A++++ (beter dan BENG)**

**100% bergen van  
hemelwater in het  
landschap**

**WKO met warmtepomp  
// gasloos**

**open-dicht verhouding gevels  
optimum tussen opwarming en  
daglicht (=beperken kunstlicht)**

**flexibiliteit en  
aanpasbaarheid van  
gebouw en installaties**

**CO2-gestuurde ventilatie  
en warmteterugwinning**

**sloop bestaande gebouw  
100% circulair**

**meubilair circulair**

**enorme vergroening  
(Trefpunt Groen)**

**minder parkeren = transitie  
naar duurzame mobiliteit**

**1000 PV panelen**

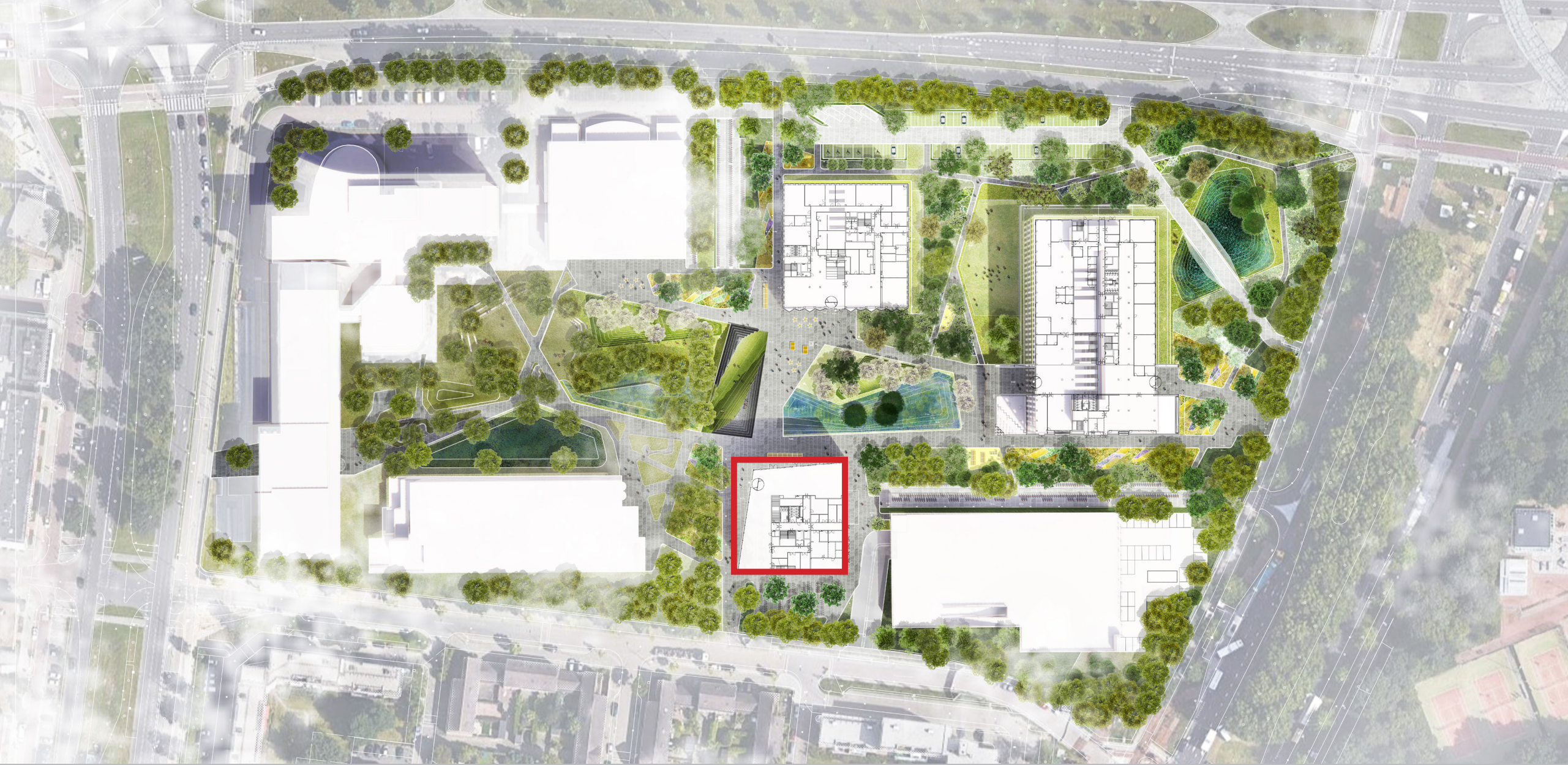

gebouw 1

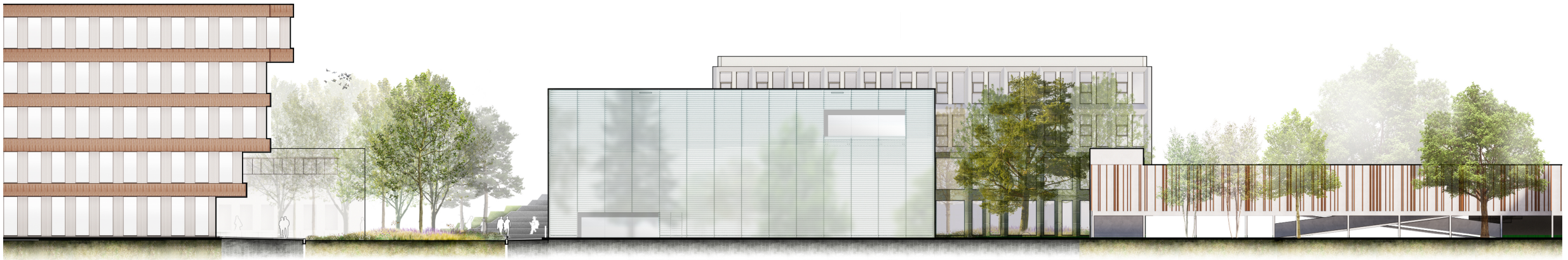
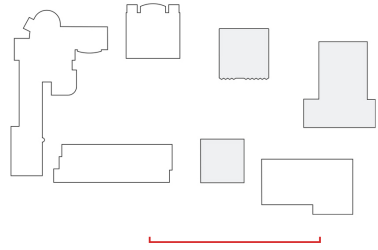

0 2,5 10 m

aanzicht vanuit Rachelsmolen - zuid



**uitnodigende zuid entree van de campus**



**transparant naar het centrale plein**





lockers

snacks & drinks

WATER POINT

SALADE BAR

FOOD

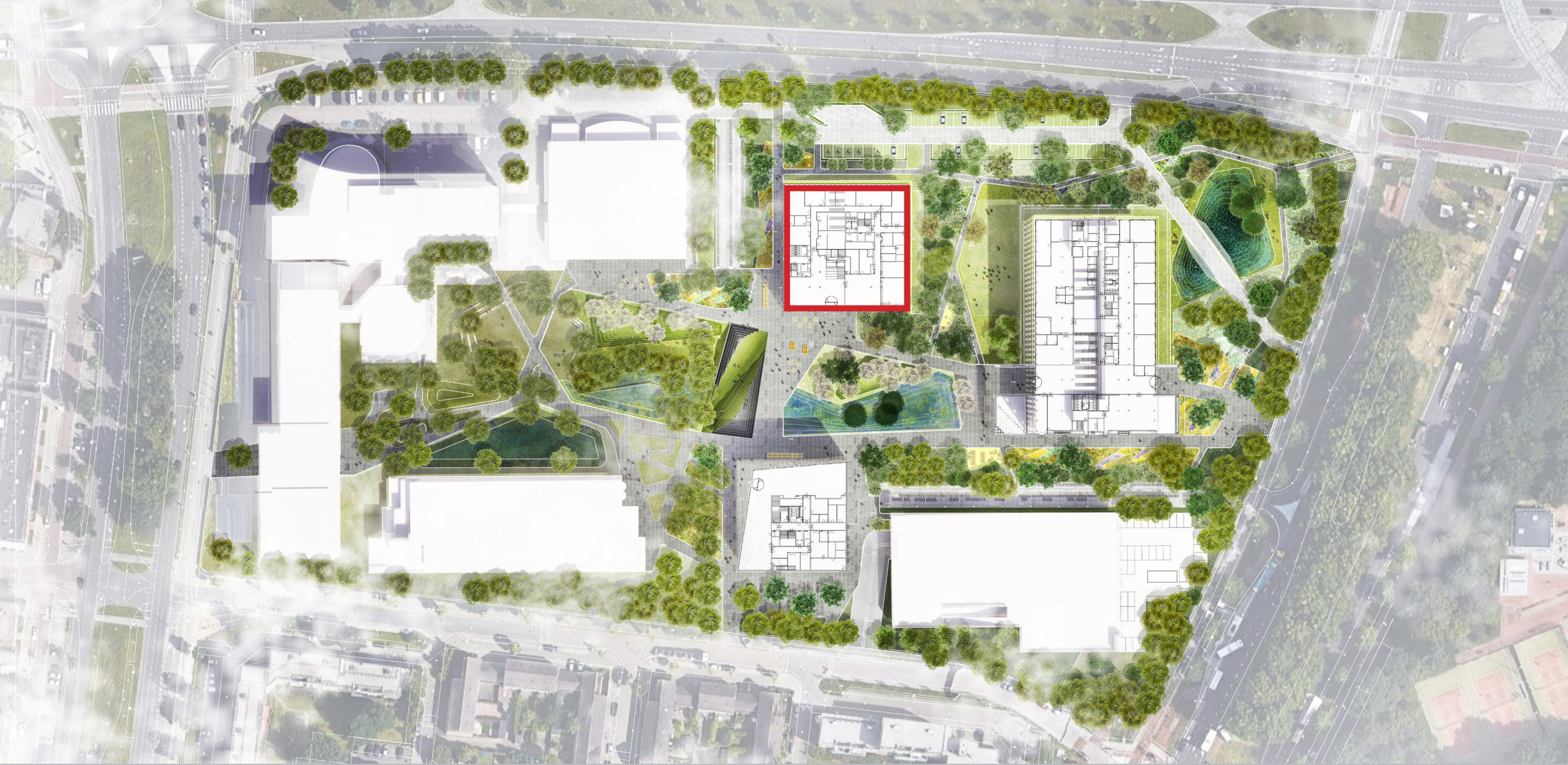

gebouw 2





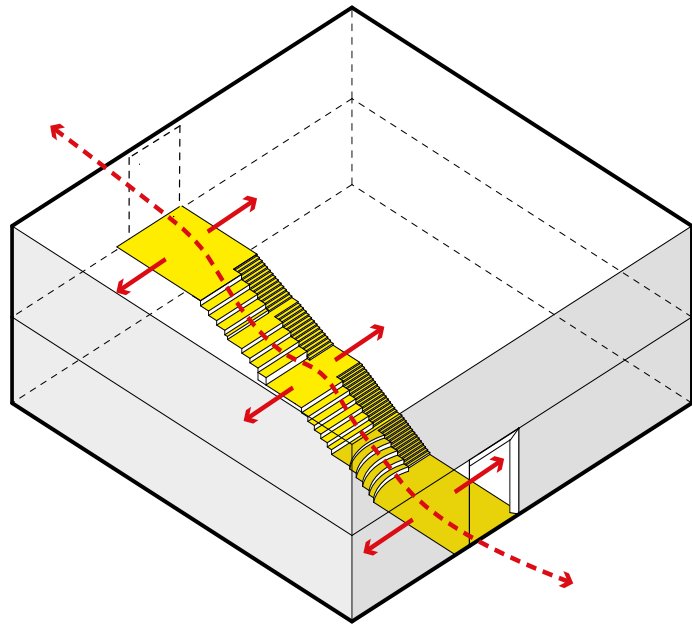

typologie van het trapatrium als verbinder  
tussen campus en stad



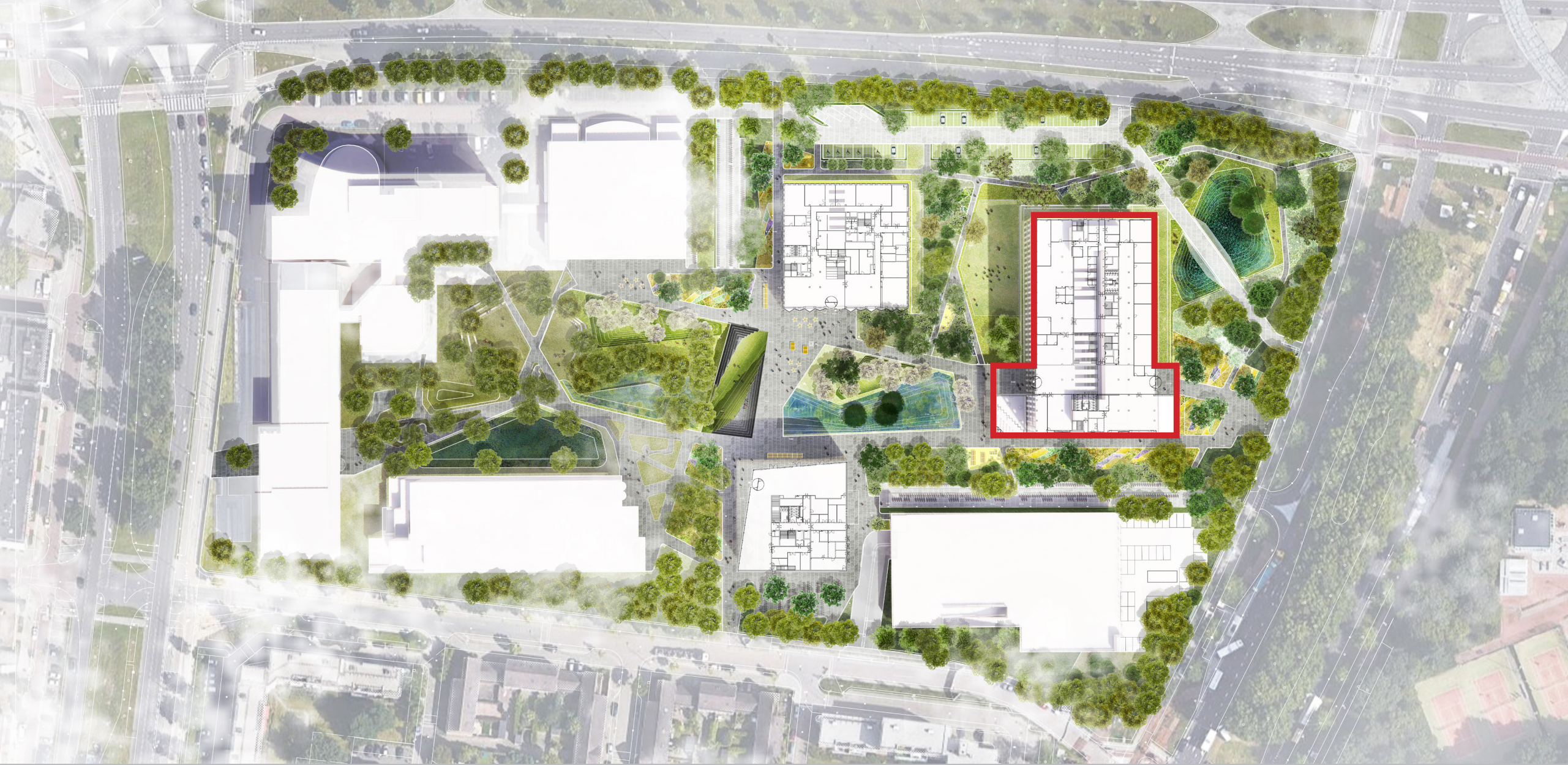

gebouw 3













# FONTYS CAMPUS RACHELSMOLEN

bewonersavond | 30-11-2020

**BARCODE**  
ARCHITECTS

OKRA

  
HOLLANDSE NIEUWE

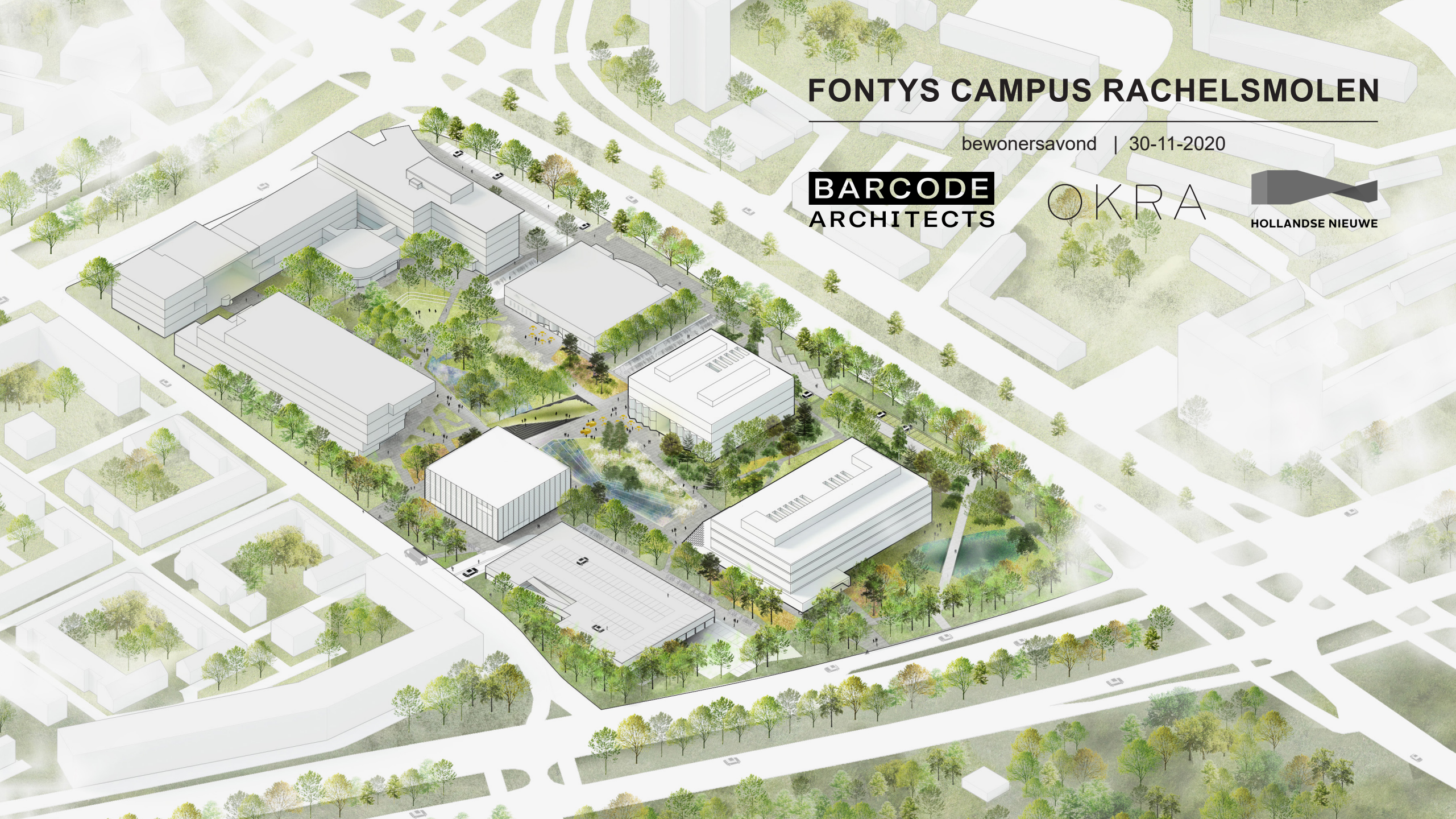



Hartelijk bedankt voor uw deelname aan de informatieavond over de (bouw)plannen op Fontys campus Rachelsmolen!

### Vragen of meer informatie?

Bezoek de website:  
[www.fontys.nl/omwonendenrachelsmolen](http://www.fontys.nl/omwonendenrachelsmolen)

Stuur een e-mail aan:  
[campusrachelsmolen@fontys.nl](mailto:campusrachelsmolen@fontys.nl)

